

Microsoft
Azure

Certified

DDoS ochrana jednoduše

RADIM ZÁPOTOCKÝ



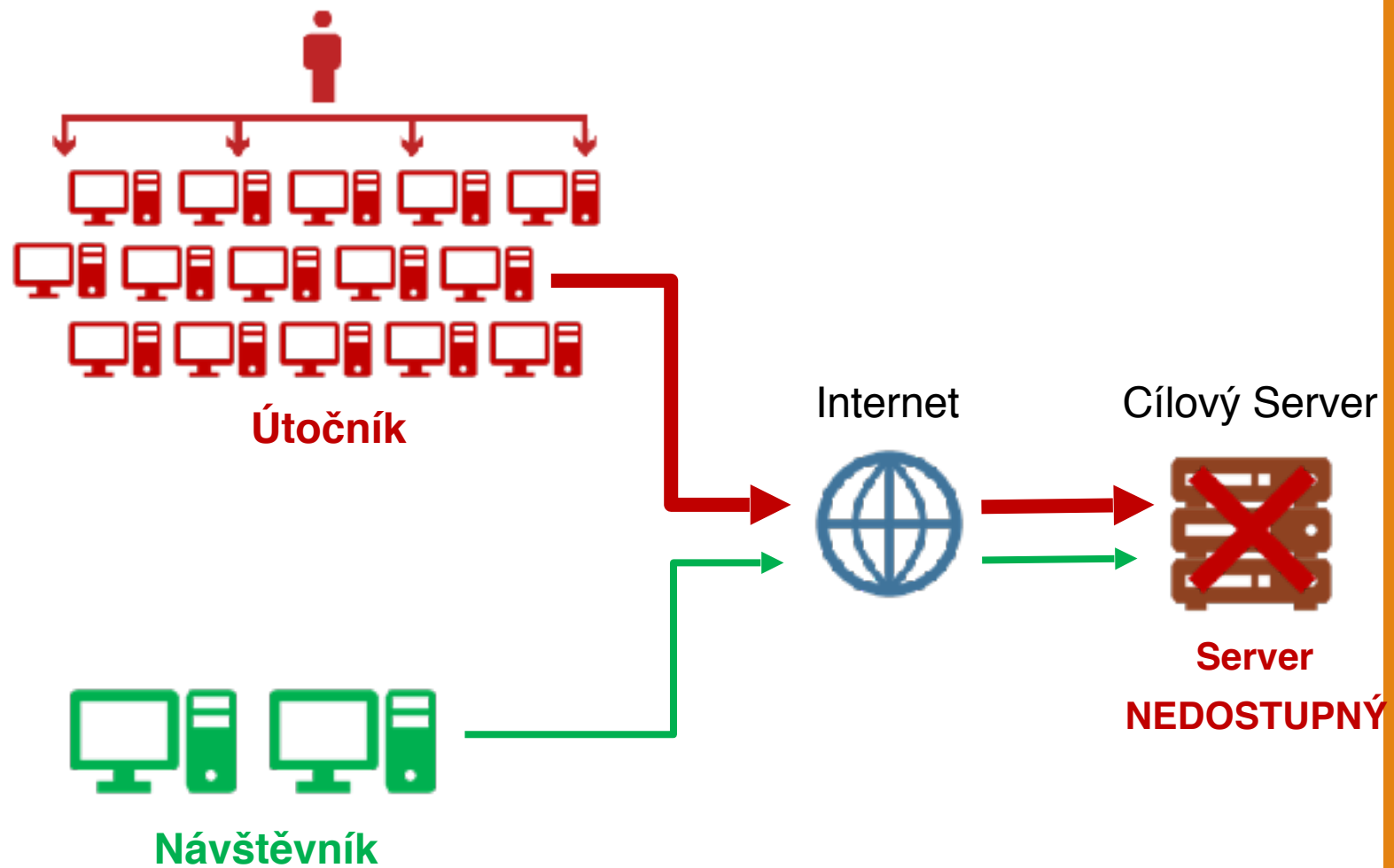

DDoS útok

- Snaha přetížit webovou službu nebo využít zranitelnost použitých protokolů
- Často využívá k útoku mnoho nakažených zařízení škodlivým kódem
- Velmi těžká ochrana v on-premise prostředí
- Může mít za následek nedostupnost všech webových služeb organizace (email, datové schránky, rejstříky, atd.).

Jak DDoS ochrana funguje?

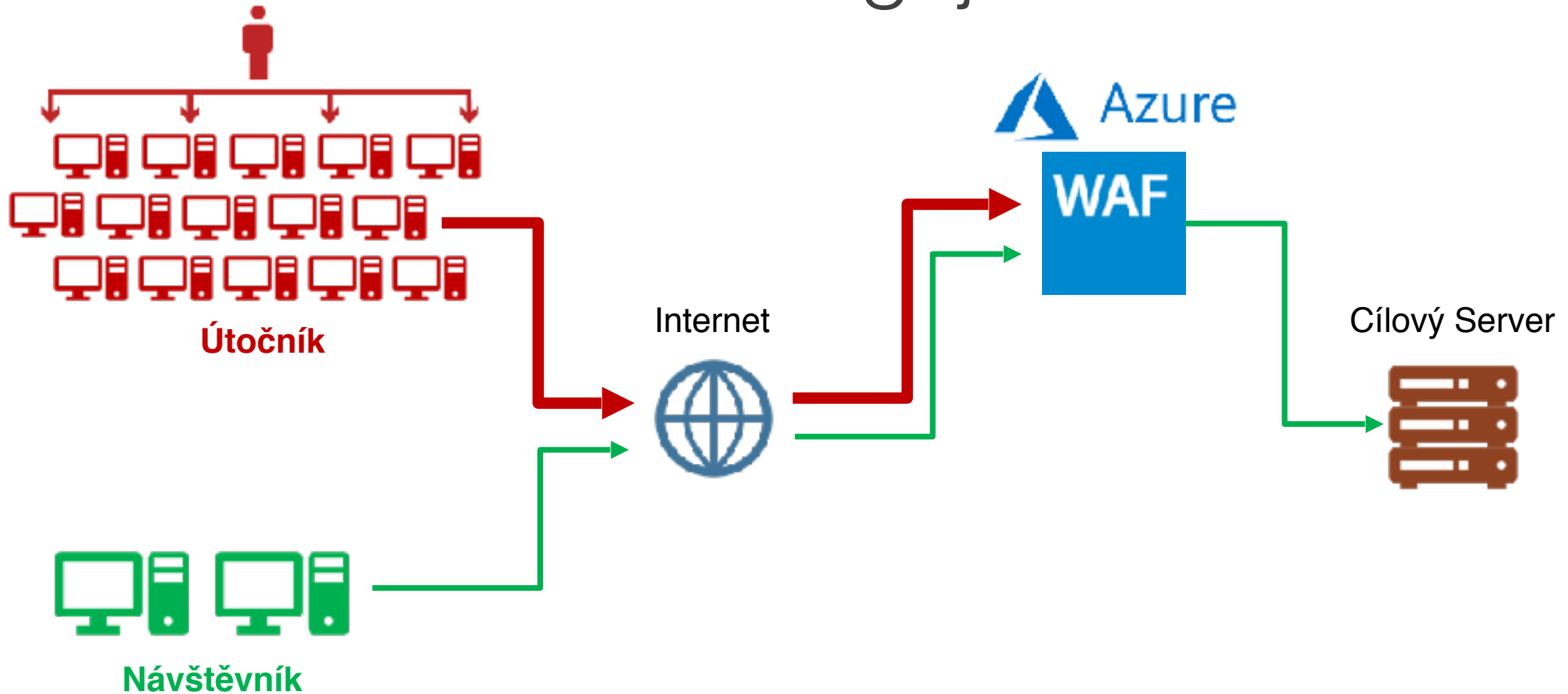

Ochrana nejen proti DDoS



Další klíčové vlastnosti

- Ochrana před zranitelností aplikačních serverů.
- Schopnost rozumět webové aplikaci.
- XSS, Buffer Overflow, SQL injection...
- Komplexní ochrana před vyvíjejícími hrozbami
- L7 load ballancing
- Podpora fungování v režimu HA



Bezpečnost &
DDoS ochrana



Monitoring
zdraví serverů



Logování
a Report



Autentizace a
Kontrola přístupu



Session
Persistence



SSL &
Výkonová akcelerace

- Možnost vyzkoušení produktu zdarma
- Dostupné jako služba
- Cena při běžné propustnosti
100Mbps 15 000 Kč / měsíc



Děkuji za pozornost

Radim Zápotocký

GESTO COMMUNICATIONS, spol. s r.o.
Distributor Barracuda Networks pro ČR a SR

Email: gesto@gestocomm.cz
Tel.: +420 267 310 034



Zařízení pro



Microsoft Teams



Radko Hochman

GESTO
COMMUNICATIONS

Zařízení pro MS Teams

- **Rozšíření user experience a možností MS Teams**
- **Koncová zařízení**
- **Infrastrukturní zařízení a služby**

Certifikace Microsoft



- Testovaná pro nejvyšší kvalitu audia a videa
- Podporovaná Microsoftem a jeho partnery
- Audio zařízení pracují s MS Teams



- Užší integrace s Microsoft Teams
- Teams user experience
- Optimalizováno pro hlasové schopnosti Microsoft Teams

office.com/teamsdevices

Zařízení pro MS Teams pro každou situaci

Prostory

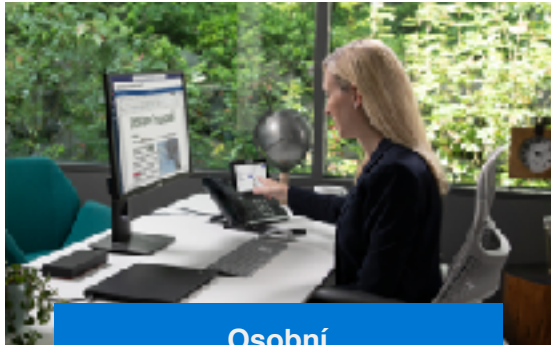

Osobní



Mobilní

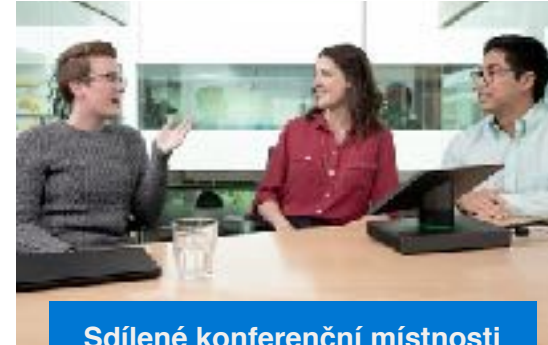

Sdílené konferenční místnosti



Malé i velké
videokonferenční místnosti

Osobní zařízení



Náhlavní
soustavy



Stolní
telefony

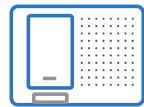

Stanice pro
mobilní telefony

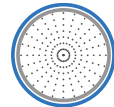

Osobní hlasité
soustavy



Mobilní
telefony

Sdílená zařízení



Konferenční
telefony

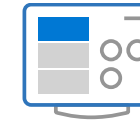

Videokonference
Microsoft
Teams Rooms



Proximity beaconing



Interaktivní
tabule

Companion Mode

Založeno na technologiích

Windows 10

Microsoft Teams

Microsoft Graph

Microsoft AI

Cortana

Teams Rooms - Vyvinuto pro spolupráci s MS Teams



Videokonferenční zařízení pro MS Teams

Podporována platforma Windows 10 nebo Android s aplikací MS Teams

Audio/Video Periferie

- Předpokládá použití vlastního Notebooku nebo PC s aplikací MS Teams
- Připojení certifikovaných periferií pro maximálně kvalitní obraz a zvuk
- Vhodné zejména pro osobní použití



Polycom Studio

Teams Room System

- Počítač s aplikací Teams Room
- Dotykový displej pro ovládání
- Jeden nebo dva displeje (lidé, obsah)
- Vysoce kvalitní cert. kamera
- Vysoce kvalitní cert. audio systém
- Podle použitých periferií vhodné pro malé, střední i velké konferenční místnosti



All-In-One

- Integrované zařízení
- MS Surface Hub
- Dotykový displej
- Mobilní
- Integrovaná aplikace interaktivní tabule



Teams Rooms - Vyvinuto pro spolupráci s MS Teams



Teams Rooms - Vyvinuto pro spolupráci s MS Teams



Doporučené sestavy videokonference pro MS Teams

Polycom + HP SRS bundle

Velká konferenční místnost

HP Slice Elite G2

Polycom Trio 8500 s přídatnými mikrofony
Kamera EagleEye IV USB, 12x optický zoom



Nově

Možnost spojení dvou zařízení
Polycom Trio pro lepší reprodukci zvuku

Střední konferenční místnost

HP Slice Elite G2

Polycom Trio 8500 s přídatnými mikrofony
Kamera EagleEye IV USB, 12x optický zoom



Nově

Kamera Polycom Cube
Digitální zoom, tracking, framing



Stolní a konferenční telefony pro MS Teams

3 PIP

- Certifikované telefony pro SfB, Teams
- Aplikace výrobce
- User experience podobná tradičnímu telefonu
- Vlastnosti a funkce závislé navýrobci a modu Teams (Island, TeamsOnly ...)



- AudioCodes UC Phones, Polycom VVX

Teams Native

- Certifikované telefony pro MS Teams
- Aplikace MS Teams
- User experience podobná MS Teams
- Vlastnosti a funkce obdobné jako MS Teams



- AudioCodes C450, Polycom Trio

Cloud Video Interoperability – certifikované pro Microsoft Teams

- HD video (1080p) a Obsah (VBSS)
- Podpora H.323 i SIP
- Nativní plánování Teams/Exchange
- Azure

Produkty



Polycom RealConnect
Service



Pexip Infinity
For Microsoft Teams



BlueJeans Gateway
For Microsoft Teams

Propojení MS Teams a veřejné telefonní sítě, pobočkové sítě

Calling Plan MS – není dostupný v ČR (a většině evropských zemí)

Teams Direct Routing

- Výrazné zjednodušení přestupu do PSTN nebo pobočkové telefonní sítě
- Není vyžadován komplikovaný a drahý Cloud Connector jako u Skype-on-line
- Podporováno MS-Teams (ne SfB on-line) s Phone System (E5 nebo extra licence)
- Point-point audio
- Variabilita – uživatel Teams může podle nastavení směřování využívat více cest (SBC / gateway) do PSTN a souběžně Direct Routing a Calling Plan
- Možnosti Voice routingu podobné jako u SfB
-  audiocodes Mediant certifikován pro Microsoft Teams

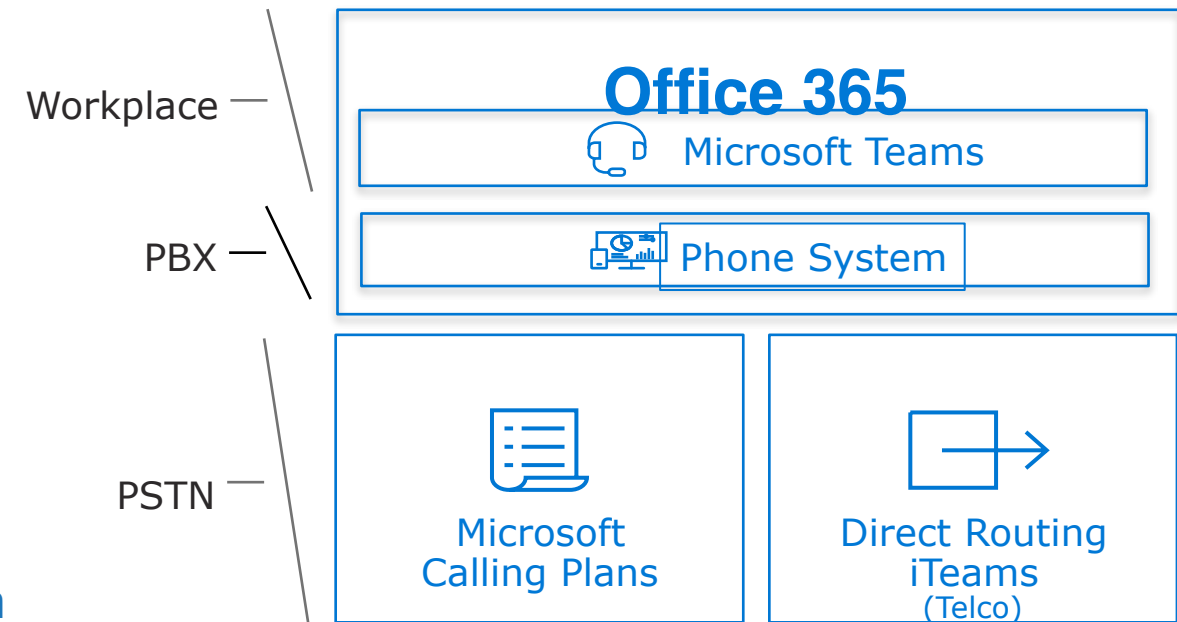

MS Teams Direct Routing

MS Certified Advanced Solution

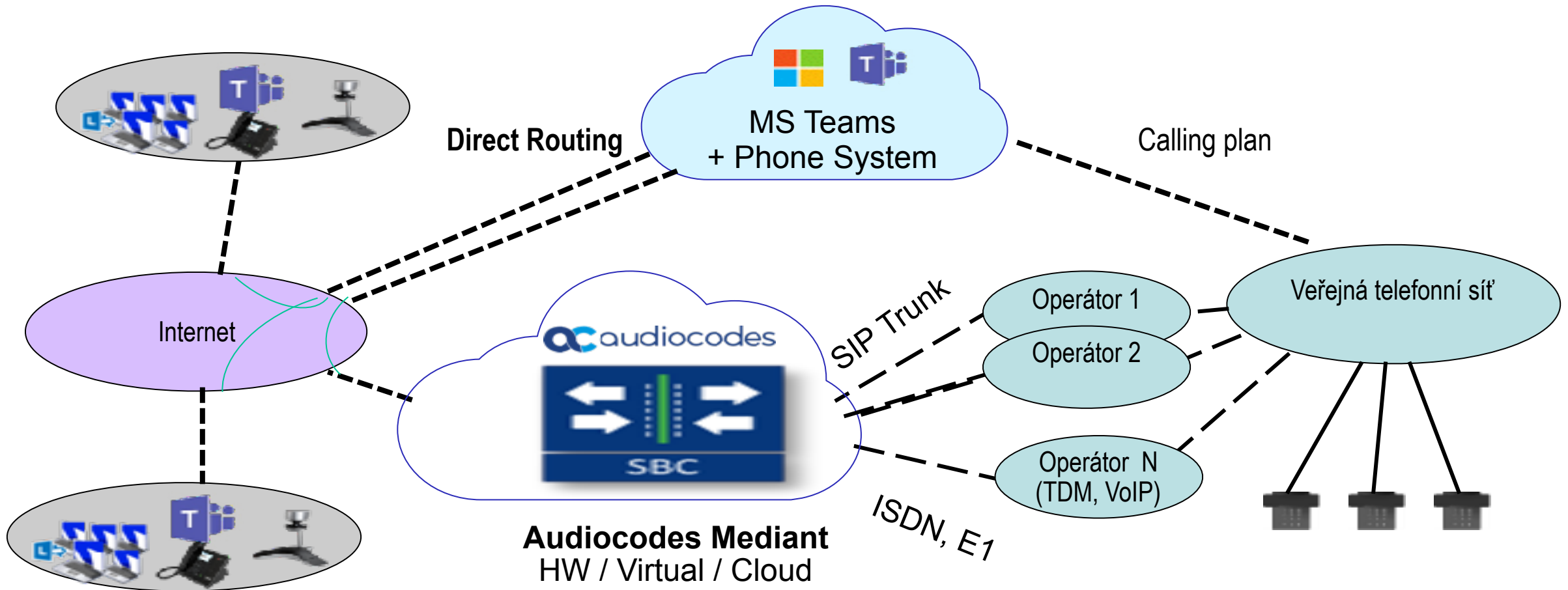

AudioCodes pro Microsoft

- Od roku 2006 užší spolupráce s Microsoft
- Produkty pro MS Lync / Skype for Business / Teams certifikované MS
- Jediná společnost která v této oblasti spolupracuje s MS od počátku doposud

- HD Telefony – podpora SfB, O365, Teams

- Hlasové Brány Mediant
 - MS SfB/O365/Teams – General SIP
 - MS SfB/O365/Teams – TDM (PRI, BRI, Analog)

- Smart Tap – Centrální záznam hovorů

- SfB : SBA, OneVoiceResilency
- O365 : CloudConnector, CloudBond 365 (SfB Hybrid All in one)
- Teams : Direct Routing

AudioCodes Mediant GW / E-SBC

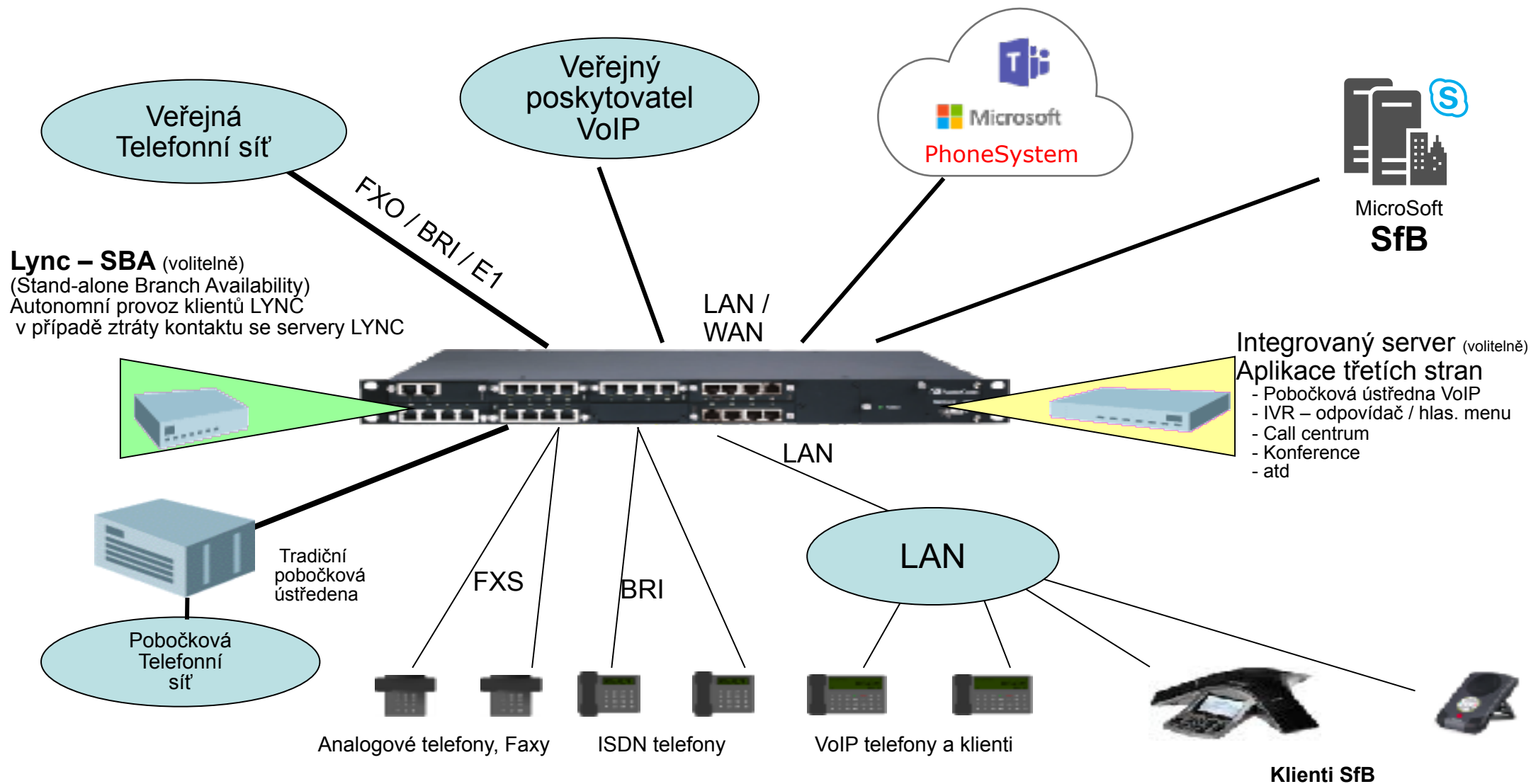

Teams Direct Routing – Jak začít

- Demo –



- Trial s využitím SBC



- Potřeba SIP trunk zákazníka do PSTN nebo PBX a PKI certifikát

- Trial s vlastním SBC

- Asistence



- Cloud nebo virtuální platforma **AudioCodes Mediant** zdarma pro 3 současná spojení – **časově neomezeno**

- Možnost zapůjčení HW varianty SBC / GW (např při požadavku připojení ISDN apod.)

- Potřeba SIP trunk zákazníka do PSTN nebo PBX (nebo tradiční připojení E1, ISDN) a PKI certifikát

AudioCodes IP Phones 400

User Experience through voice quality, intuitive design, and powerful features

AudioCodes Managed IP Phone solution Now support **Silk!**



Low-cost, entry level model
Basic LCD with 4 programmable soft keys
*1GB Eth & USB starting July 16
405 IP Phone



Cost-effective, basic model
Basic LCD with 4 programmable soft keys
1GB Eth (Optional)

420HD IP Phone



Mid-range model
Boast a large LCD and 12 programmable speed dials keys
USB Port
1GB Eth (Optional)

430HD IP Phone



Advanced mid-range model
Improved Graphic LCD
256x128 Dedicated LCD displaying
12 contacts and their presence
1GB Eth
USB Port

440HD IP Phone



High end, executive model
5" TFT 800x480 touch screen
Integrated Bluetooth,
USB Port
1GB Eth
Optional Expansion unit

450HD IP Phone

AudioCodes provides **INNOVATIVE, MANAGED, RESILIENT** Solution at affordable price



Compatible

AudioCodes IP Phone C450HD



Microsoft Teams

Native



Native Teams experience

Dual software

Native Teams / AudioCodes (3PIP)

Displej :

5" barevný dotykový 720X1280

Rozšiřující jednotka :

5" barevný dotykový displej 800x480

Rozhraní

Integrovaný Bluetooth (volitelně)

Integrated Wi-Fi (volitelně)

2 X Gigabit Ethernet

2 x USB 2.0

AudioCodes pro Microsoft UC

Aplikace



Routing Manager IP Phone Manager



OVOC

AutoAttendnt

Call Recording Fax Server

All-in-One
a Cloud



CloudBond 365



CloudBond 365 CCE and OPCH

Telefony



C450 Teams & 450



445



440



430



420



405

Audio
Konference



HRS

Hardware a
Software SBC



Mediant 2600



Mediant 4000



Mediant 9000



Mediant Virtual Edition & Software Edition



Gateway/SBC,
SBA



Mediant 800



Mediant 1000



Mediant 3000

GatewayS/ATA



MP124/1xx



MP2xx



MP1288